

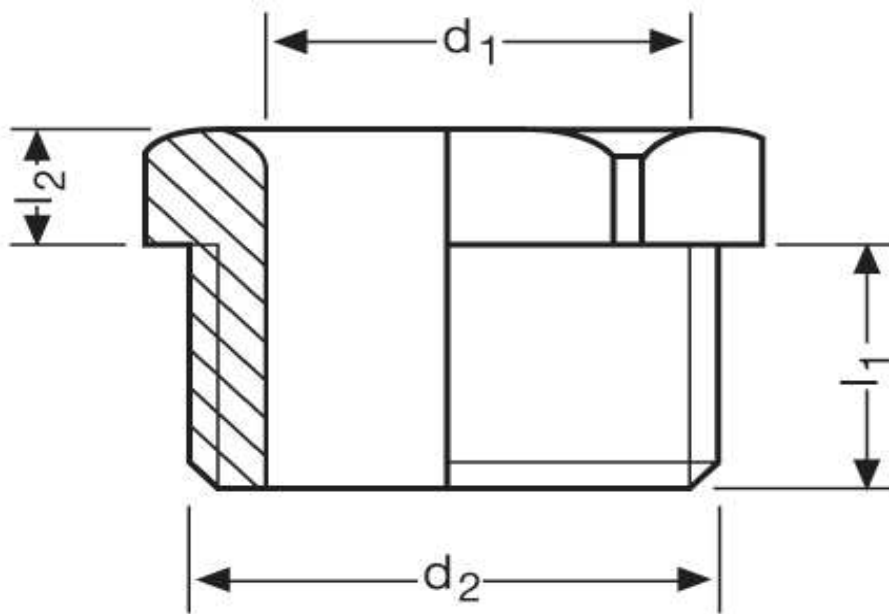

**Druckschraube G 71
DIN 46320**



Katalogseite: 9.26

Art.Nr.	Farbe	Material	Nenngröße		
G 871160	grau	Polystyrol schlagfest	PG 16	100	
G 871161	grau	Polyamid glasfaserverstärkt			
	d2	d1	l2	l1	
in mm:	22,5	15,5	11,50	15,5	23