

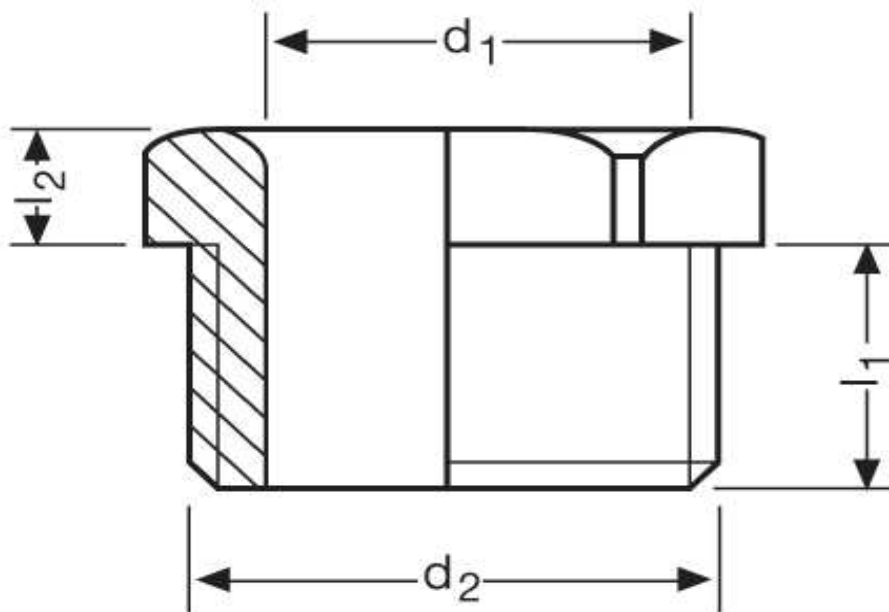

**Druckschraube G 71  
DIN 46320**



Katalogseite: 9.26

Art.Nr.	Farbe	Material	Nenngröße		
G 871360	grau	Polystyrol schlagfest	PG 36	25	
G 871361	grau	Polyamid glasfaserverstärkt			
	d2	d1	l2	l1	
in mm:	47,0	34,0	17,00	25	50