

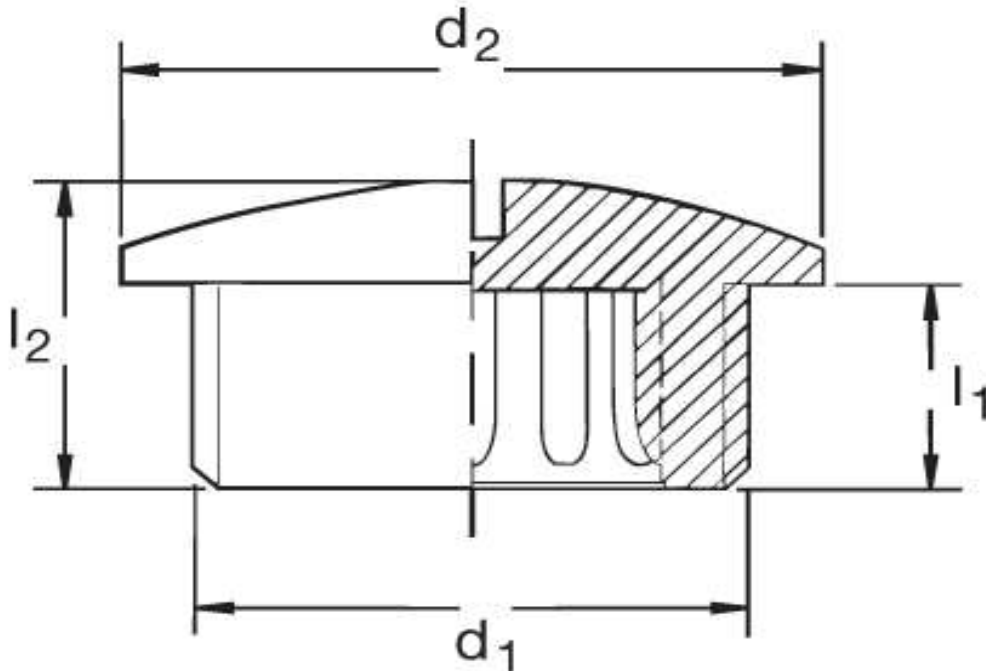

Verschlusschraube G 72
DIN 46320

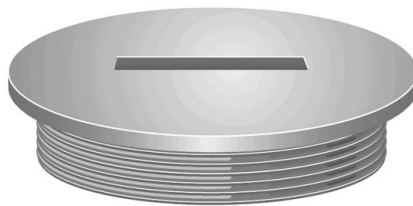

Katalogseite: 9.27

Art.Nr.	Farbe	Material	Nenngröße	
G 872070	grau	Polystyrol schlagfest	PG 7	100
G 872071	grau	Polyamid glasfaserverstärkt		
	d1	d2	l1	l2
in mm:	12,5	15,0	6,00	8