

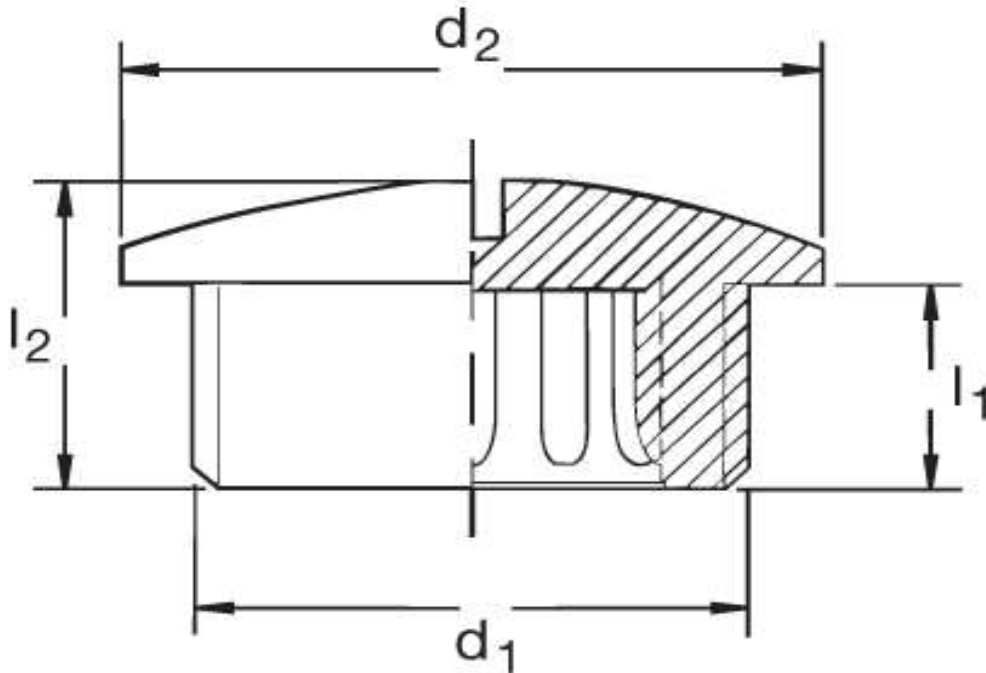

Verschlusschraube G 72  
DIN 46320

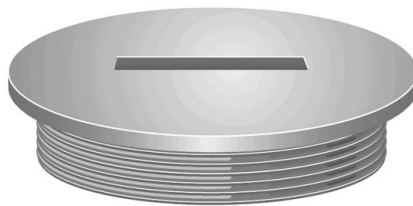

Katalogseite: 9.27

Art.Nr.	Farbe	Material	Nenngröße	
G 872290	grau	Polystyrol schlagfest	PG 29	100
G 872291	grau	Polyamid glasfaserverstärkt		
	d1	d2	l1	l2
in mm:	37,0	44,0	8,00	12