

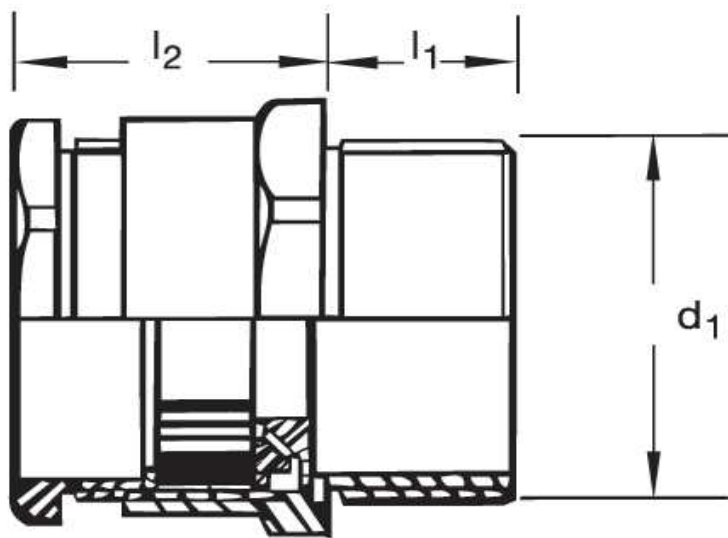

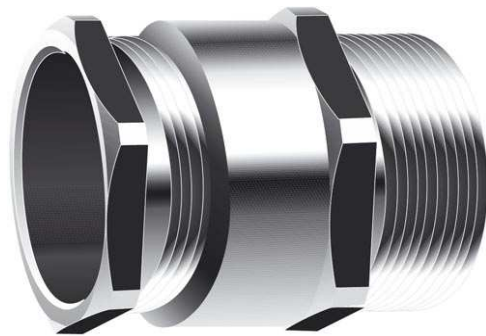

Kabelverschraubung GM 11
DIN 46320 C 4



Katalogseite: 9.03

Art.Nr.	Werkstoff	Nenngröße		Kabel Ø
GM 811110.*	Mess. vern.	PG 11,0 N	50	8 - 10
	d1	l1	l2	
in mm:	18,6	6,0	17,00	
Bestellcode Dichtring	*1 einteilig		*2 ausschneidbar	