

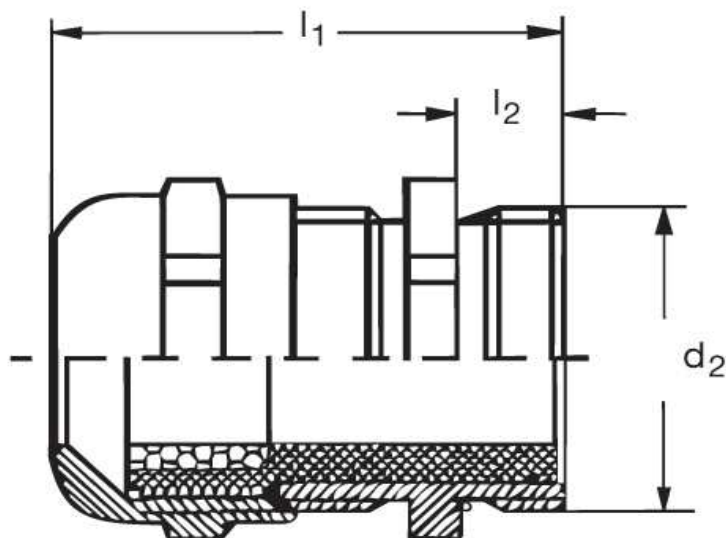

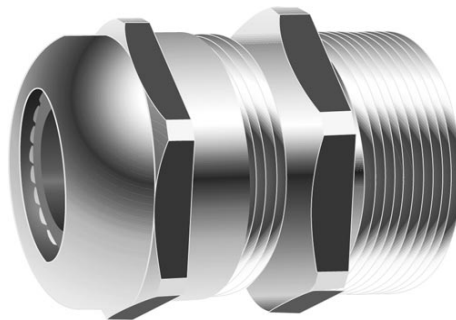

Kabelverschraubung GM 20



Katalogseite: 9.04

Art.Nr.	Werkstoff	Nenngröße		Kabel Ø
GM 820130	Mess. vern.	PG 13,5 N	50	8 - 13
	d1	l1	l2	
in mm:	20,4	6,5	22,00	