

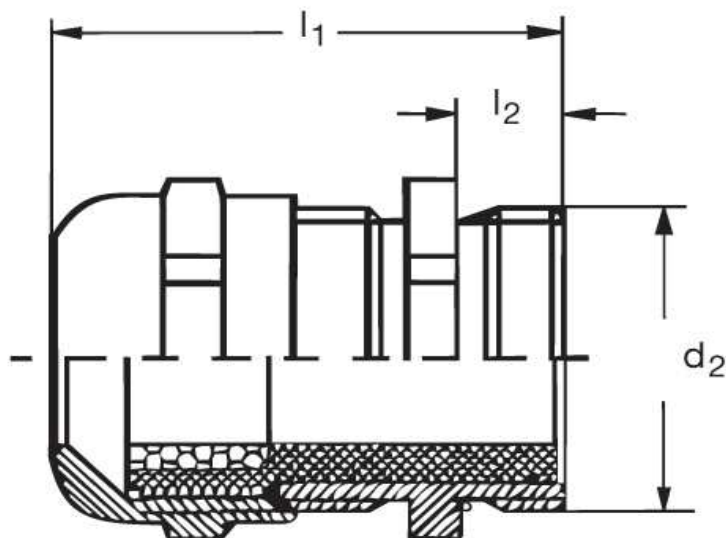

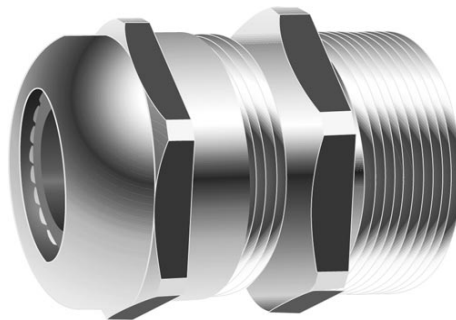

Kabelverschraubung GM 20



Katalogseite: 9.04

Art.Nr.	Werkstoff	Nenngröße		Kabel Ø
GM 820420	Mess. vern.	PG 42,0 N	10	32 - 38
	d1	l1	l2	
in mm:	54,0	9,0	37,00	