

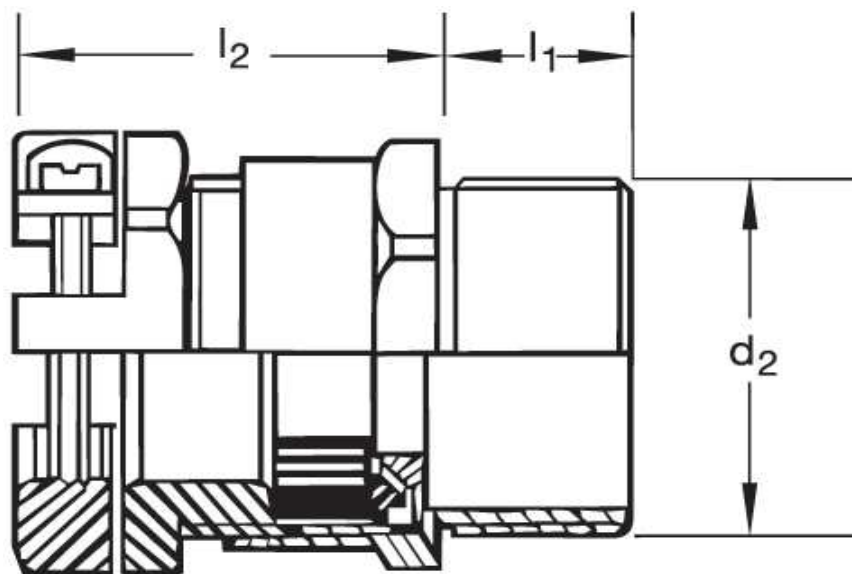

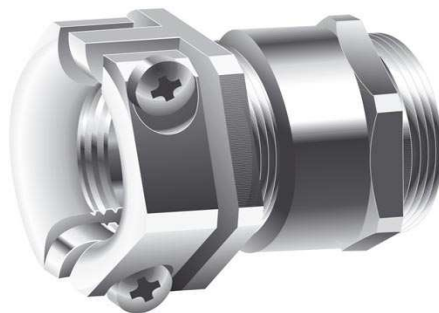

Kabelverschraubung GM 30



Katalogseite: 9.06

Art.Nr.	Werkstoff	Nenngröße		Kabel Ø
GM 8300200	Mess. vern.	M 20 / PG 11	50	7,5 - 11,5
	d1	l1	l2	
in mm:	20,0	6,5	26,00	