

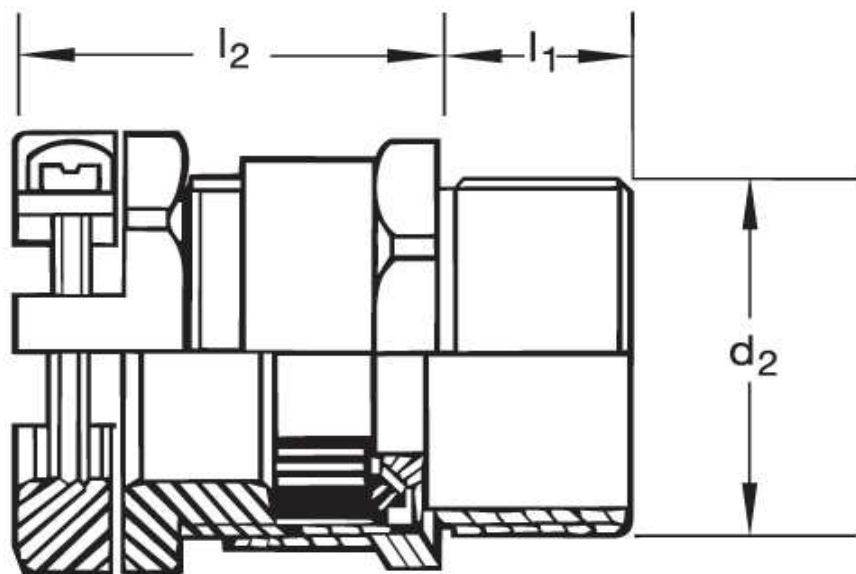

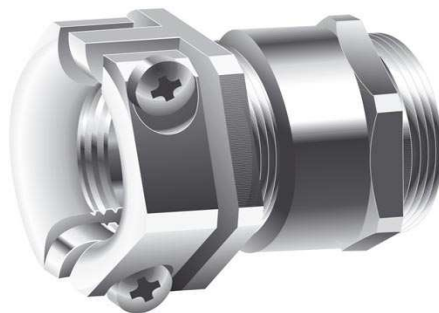

Kabelverschraubung GM 30



Katalogseite: 9.06

Art.Nr.	Werkstoff	Nenngröße		Kabel Ø
GM 8300250	Mess. vern.	M 25 / PG 16	50	11,5 - 14,5
	d1	l1	l2	
in mm:	25,0	7,0	29,00	