

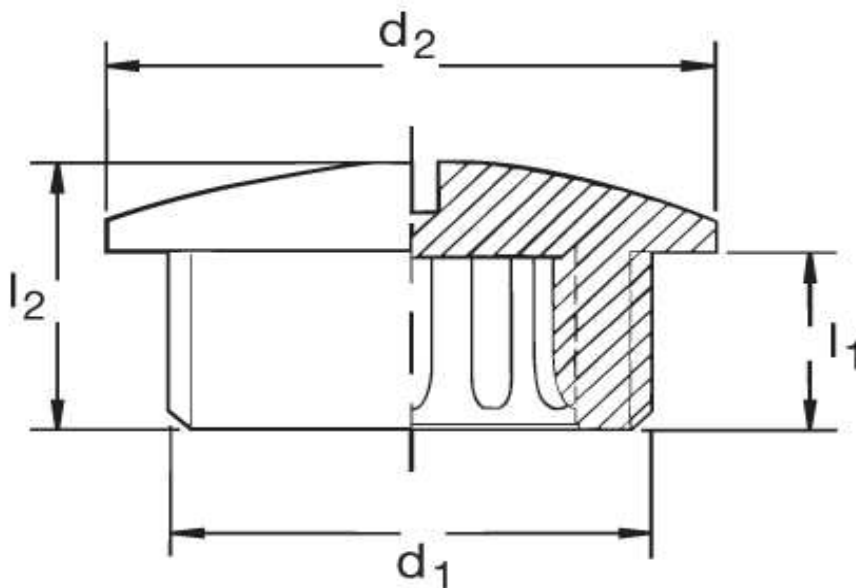



Verschlusschraube GM 72

DIN 46320 und EN 60423



Katalogseite: 9.13

Art.Nr.	Werkstoff		Nenngröße	
GM 872070	Mess. Vern.	100	PG 7	
	d1	d2	l2	l1
in mm:	12,5	14,0	8,00	5,00