



Eisenacher
elektroTECHNIK GmbH

Kabel-Anschluss- und Verbindungstechnik

Verschlusschraube GM 72

DIN 46320 und EN 60423

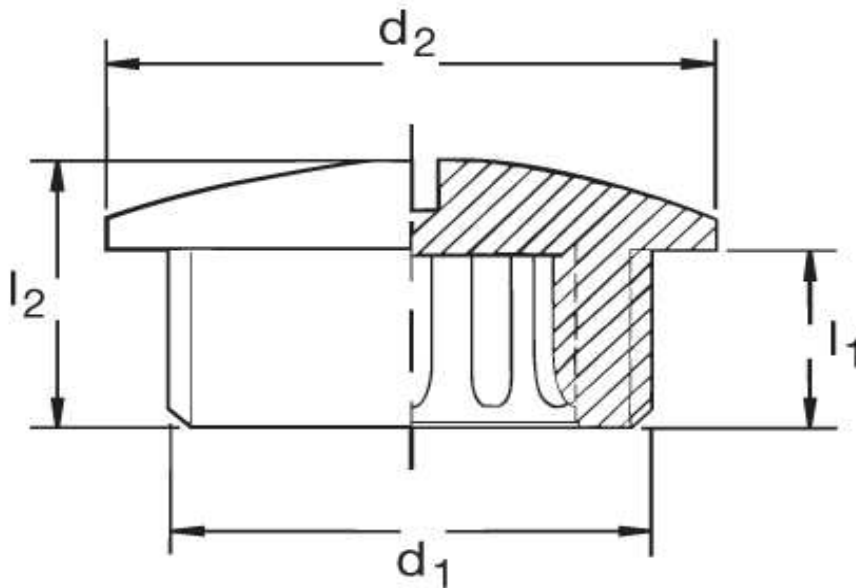

Katalogseite: 9.13

Art.Nr.	Werkstoff		Nenngröße	
GM 872090	Mess. Vern.	100	PG 9	
	d1	d2	l2	l1
in mm:	15,2	17,0	9,00	6,00