

Quetschkabelschuhe

Ringform
1,5 mm² M 2,5

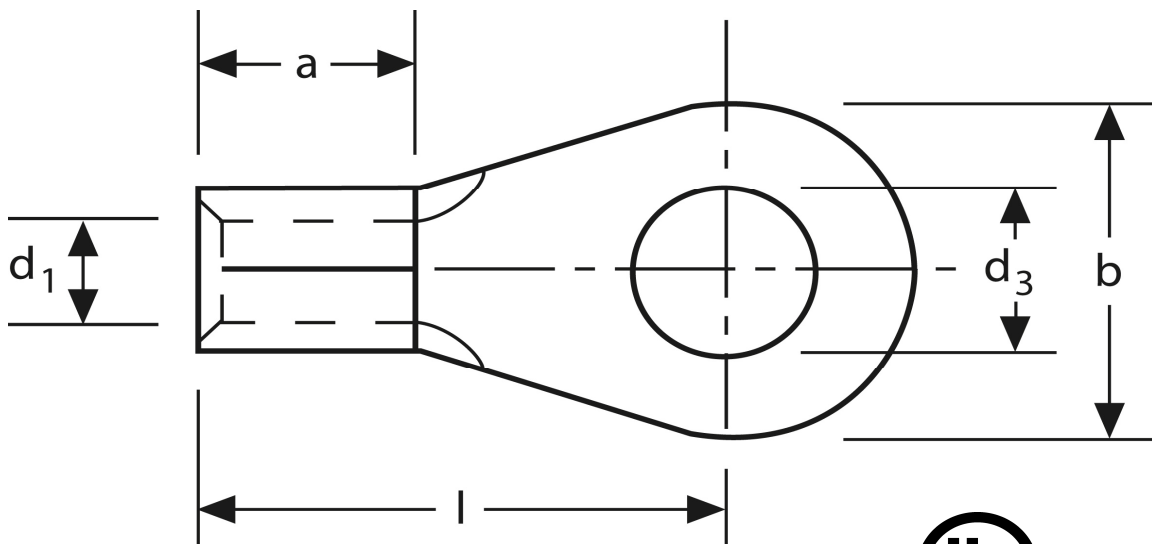

Art.Nr.	Werkstoff	Oberfläche		
K 301025	E-CU	galv. Sn	0,58 / 1000	1.000
	d₃	d₁	b	
in mm:	2,7	1,6	6	
	l	a	s	
in mm:	11	5	0,8	

Stand: 08.07.2014

Solderless terminals
ring-type
1,5 mm² M 2,5

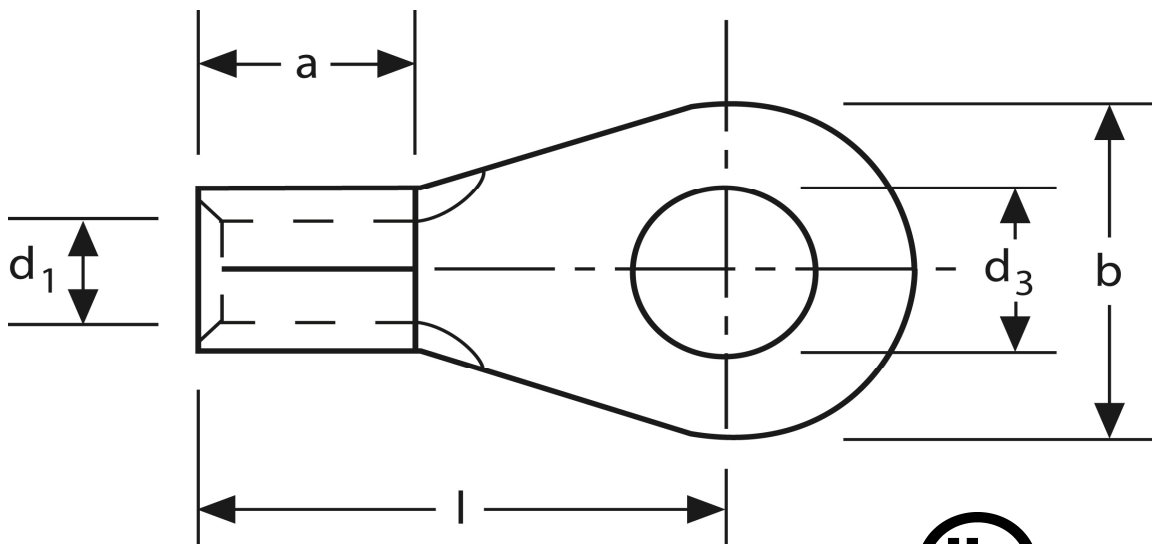

part no.	material	surface		
K 301025	E-CU	tin-plated	0,58 / 1000	1.000
	d₃	d₁	b	
in mm:	2,7	1,6	6	
	l	a	s	
in mm:	11	5	0,8	

date: 08.07.2014