

Quetschkabelschuhe

Ringform
 1,5 mm² M 5

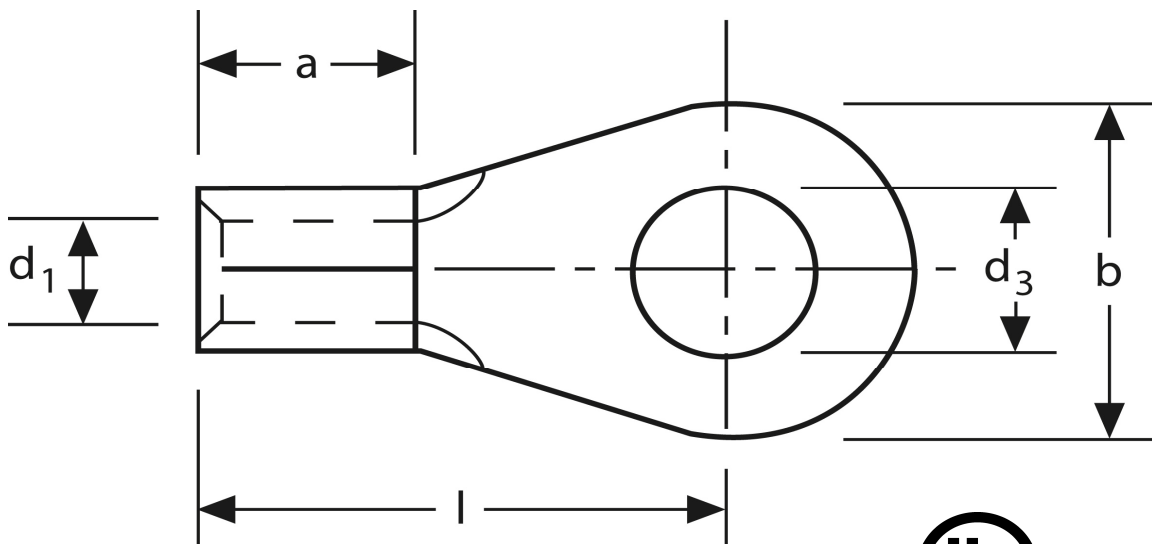

Art.Nr.	Werkstoff	Oberfläche		
K 301050	E-CU	galv. Sn	0,90 / 1000	1.000
	d₃	d₁	b	
in mm:	5,3	1,6	10	
	l	a	s	
in mm:	13	5	0,8	

Stand: 08.07.2014

Solderless terminals
ring-type
1,5 mm² M 5

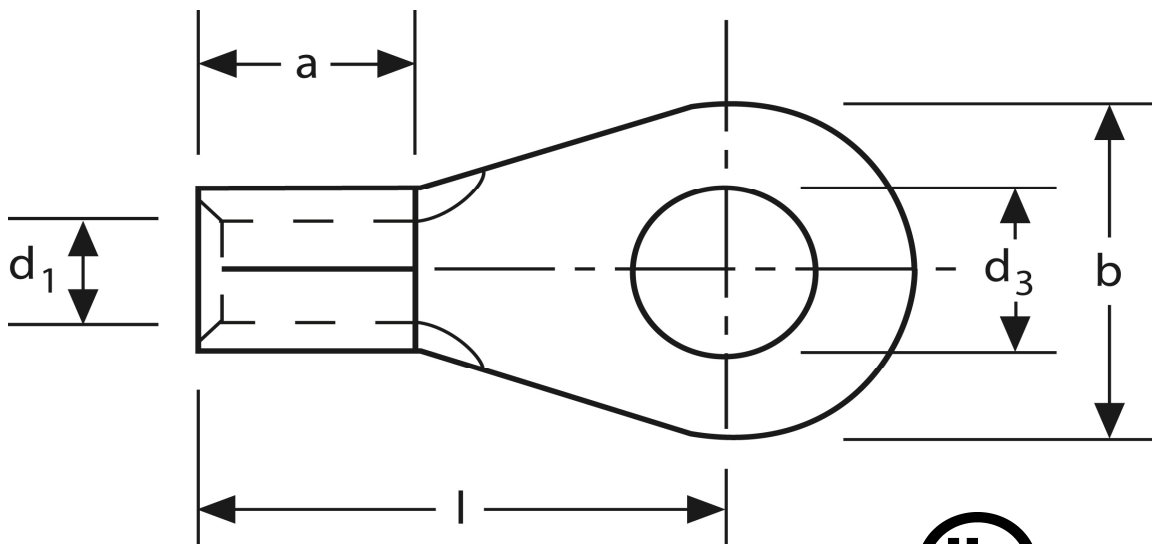

part no.	material	surface		
K 301050	E-CU	tin-plated	0,90 / 1000	1.000
	d₃	d₁	b	
in mm:	5,3	1,6	10	
	l	a	s	
in mm:	13	5	0,8	

date: 08.07.2014