

Quetschkabelschuhe

Ringform
25 mm² M 6

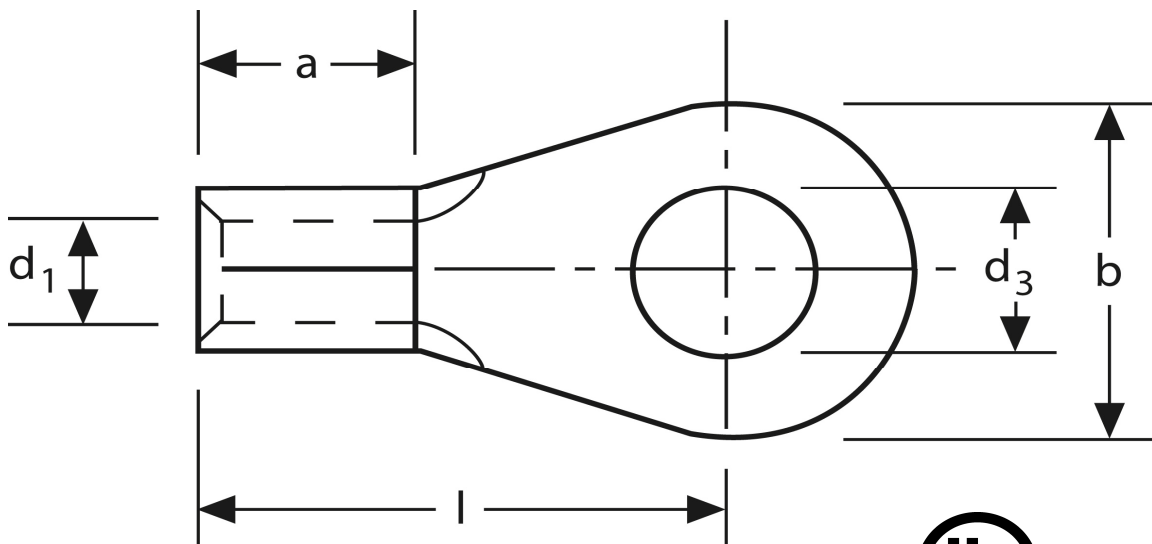

Art.Nr.	Werkstoff	Oberfläche		
K 306060	E-CU	galv. Sn	7,6 / 1000	200
	d ₃	d ₁	b	
in mm:	6,5	7,5	12	
	l	a	s	
in mm:	25	11	1,5	

Stand: 08.07.2014

Solderless terminals
ring-type
25 mm² M 6

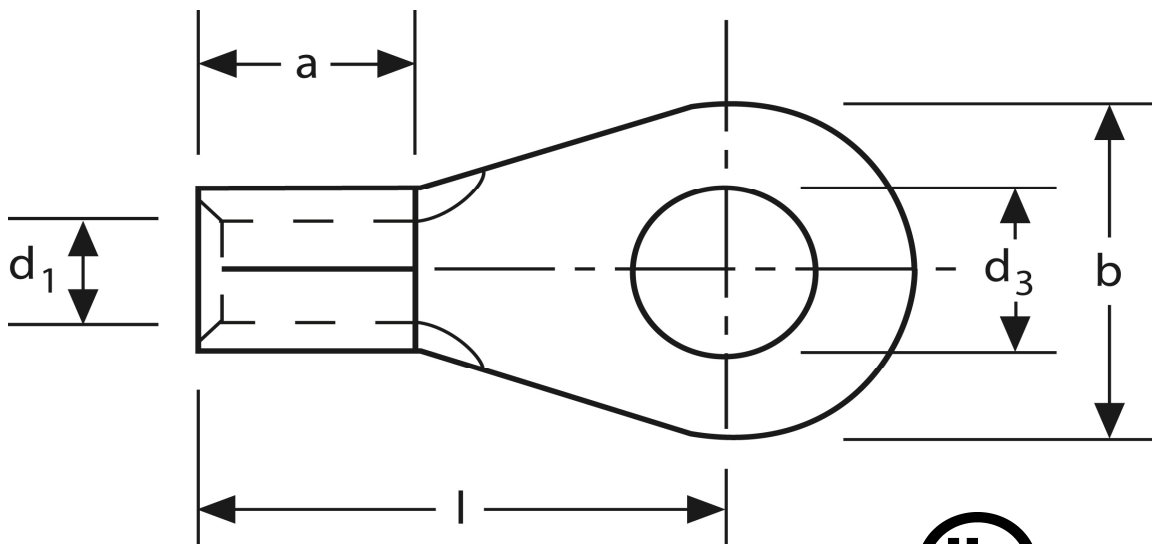

part no.	material	surface		
K 306060	E-CU	tin-plated	7,6 / 1000	200
	d₃	d₁	b	
in mm:	6,5	7,5	12	
	l	a	s	
in mm:	25	11	1,5	

date: 08.07.2014