

Quetschkabelschuhe

Ringform
 25 mm² M 8

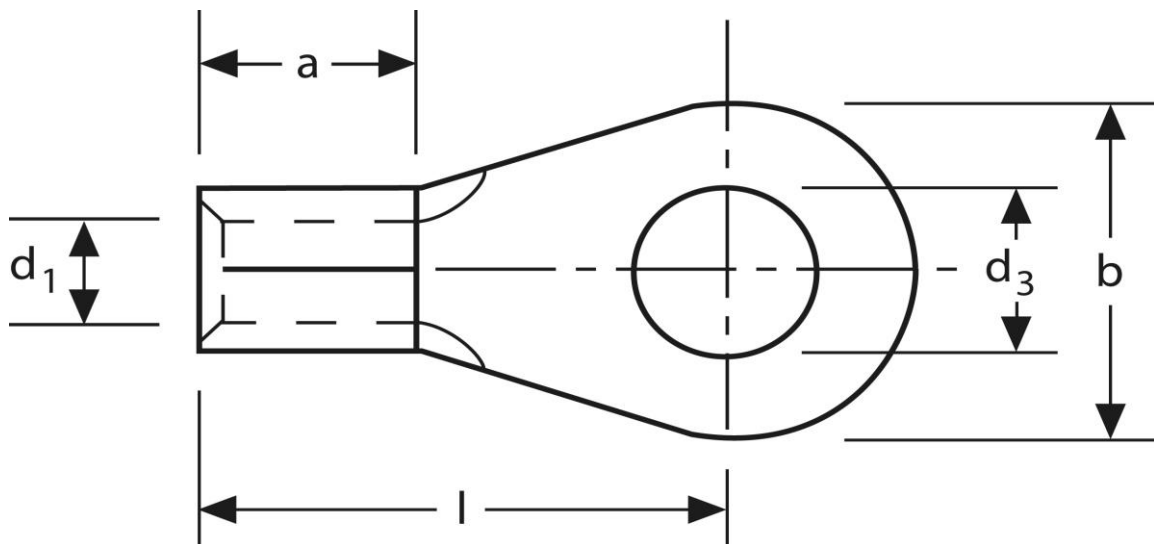

Art.Nr.	Werkstoff	Oberfläche		
K 306080.1	E-CU	galv. Sn	7,90 / 1000	200
	d ₃	d ₁	b	
in mm:	8,4	7,5	16	
	l	a	s	
in mm:	25	11	1,5	

Stand: 25.01.2019

Solderless terminals
ring-type
25 mm² M 8

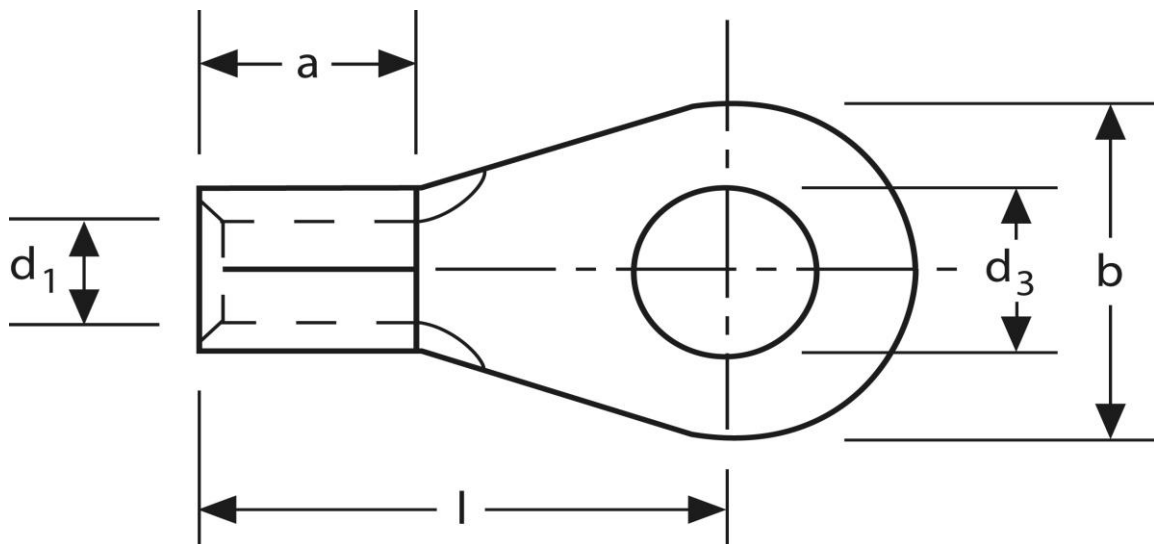

part no.	material	surface		
K 306080.1	E-CU	tin-plated	7,90 / 1000	200
	d₃	d₁	b	
in mm:	8,4	7,5	16	
	l	a	s	
in mm:	25	11	1,5	

date: 25.01.2019