

## Quetschkabelschuhe

Ringform  
35 mm<sup>2</sup> M 8

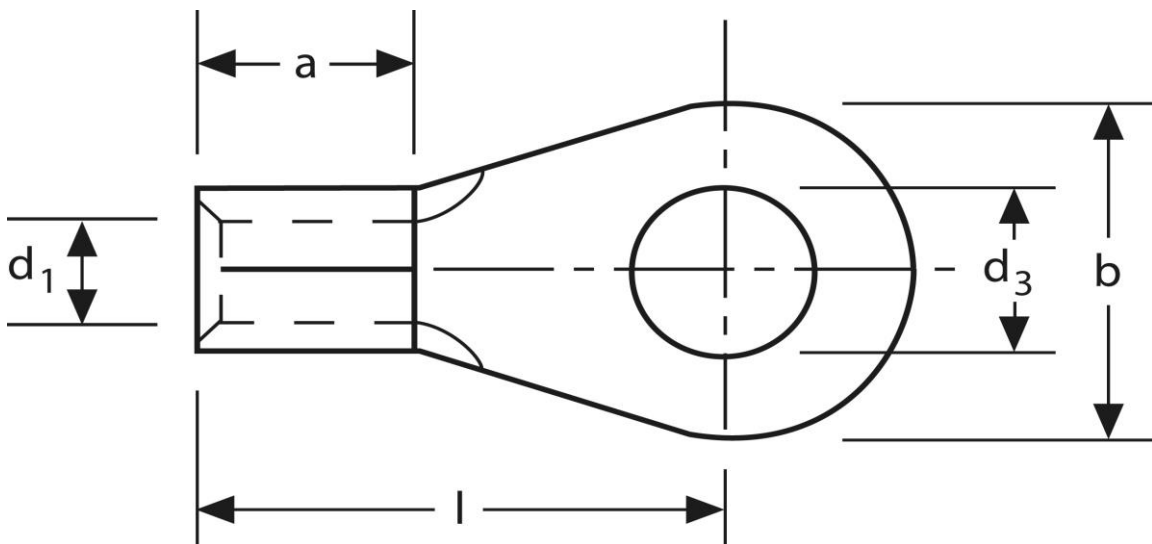

Art.Nr.	Werkstoff	Oberfläche		
K 307080.1	E-CU	galv. Sn	9,80 / 1000	200
	d <sub>3</sub>	d <sub>1</sub>	b	
in mm:	8,4	9,0	16	
	l	a	s	
in mm:	26	12	1,6	

Stand: 25.01.2019

**Solderless terminals**  
 ring-type  
 35 mm<sup>2</sup> M 8

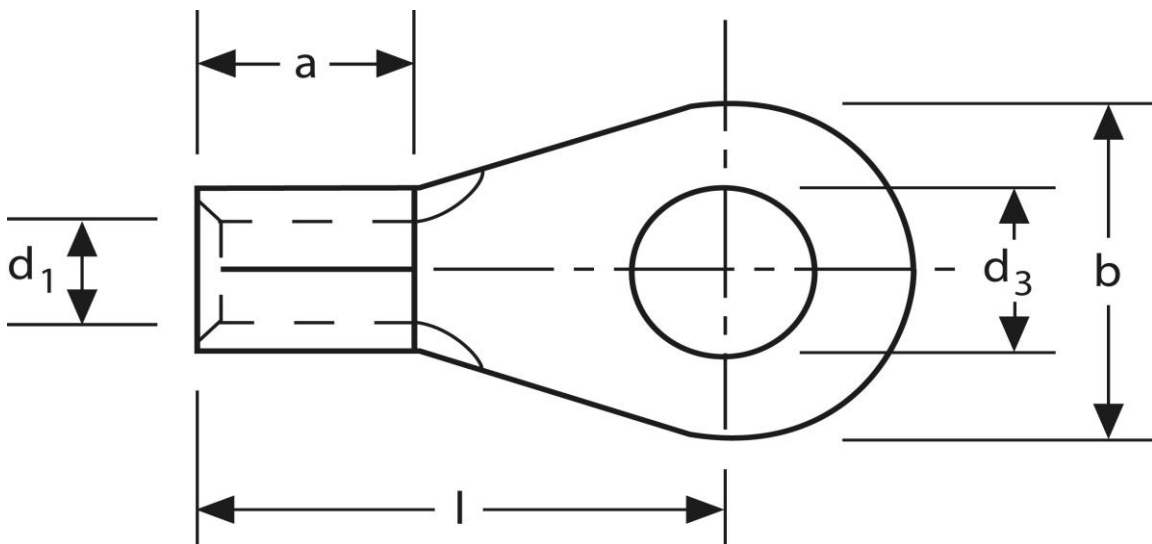

part no.	material	surface		
K 307080.1	E-CU	tin-plated	9,80 / 1000	200
	<b>d<sub>3</sub></b>	<b>d<sub>1</sub></b>	<b>b</b>	
<b>in mm:</b>	8,4	9,0	16	
	<b>l</b>	<b>a</b>	<b>s</b>	
<b>in mm:</b>	26	12	1,6	

date: 25.01.2019