

Quetschkabelschuhe

Ringform
35 mm² M 8

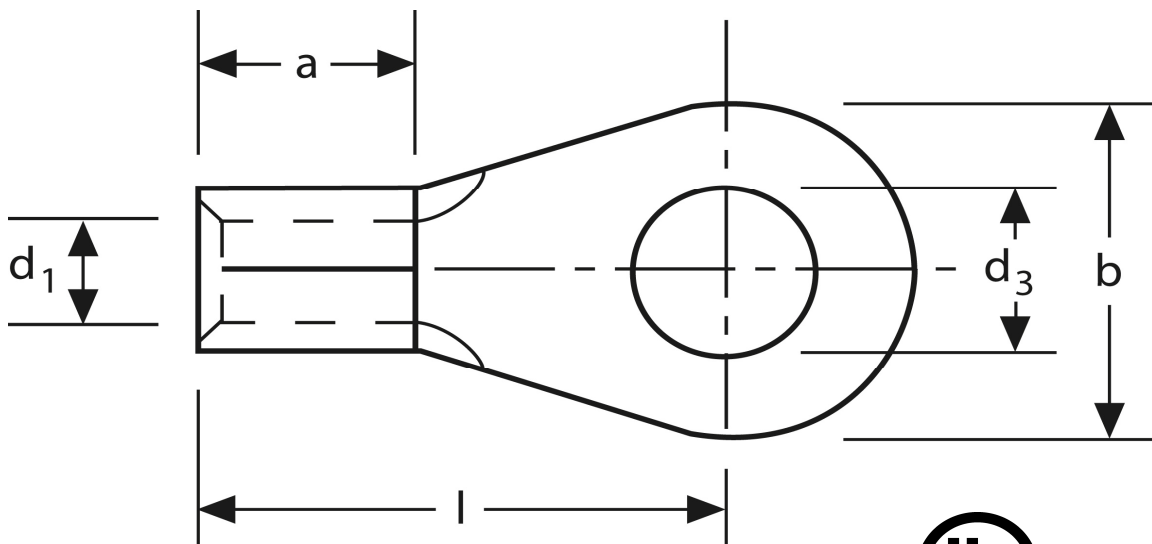

Art.Nr.	Werkstoff	Oberfläche		
K 307080	E-CU	galv. Sn	9,8 / 1000	200
	d₃	d₁	b	
in mm:	8,4	9,0	16	
	l	a	s	
in mm:	26	12	1,6	

Stand: 08.07.2014

Solderless terminals
ring-type
35 mm² M 8

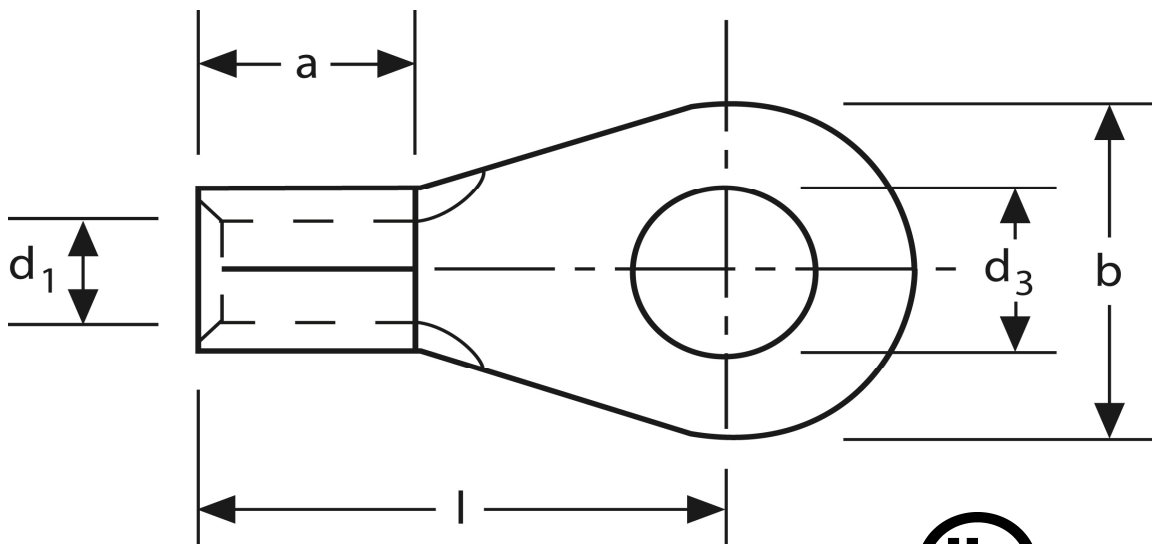

part no.	material	surface		
K 307080	E-CU	tin-plated	9,8 / 1000	200
	d₃	d₁	b	
in mm:	8,4	9,0	16	
	l	a	s	
in mm:	26	12	1,6	

date: 08.07.2014