

Quetschkabelschuhe

Ringform
50 mm² M 8

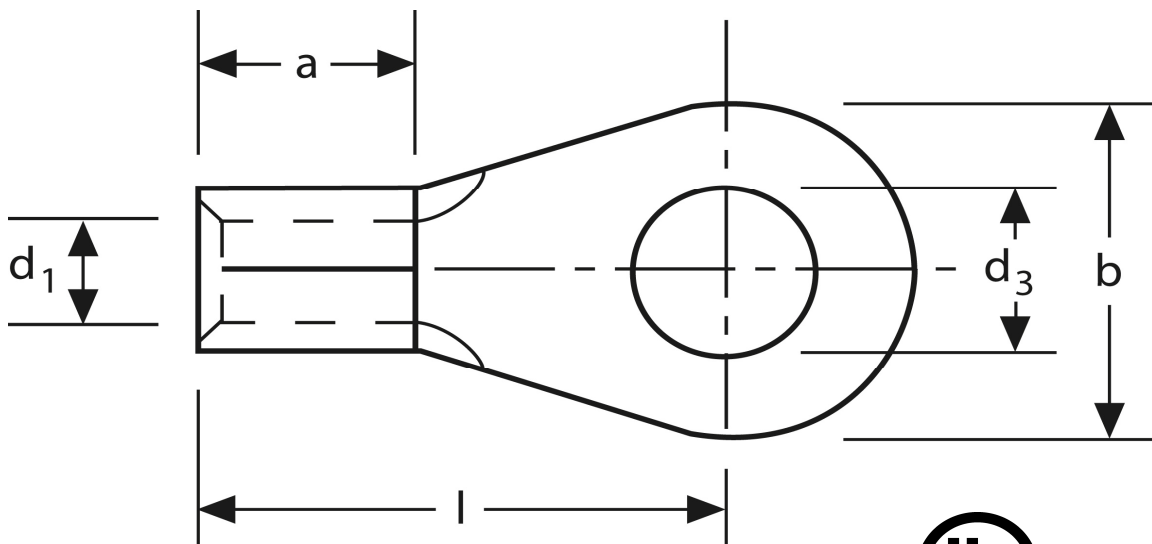

Art.Nr.	Werkstoff	Oberfläche		
K 308080	E-CU	galv. Sn	16,5 / 1000	100
	d₃	d₁	b	
in mm:	8,4	11,0	18	
	l	a	s	
in mm:	34	16	1,8	

Stand: 08.07.2014

Solderless terminals
ring-type
50 mm² M 8

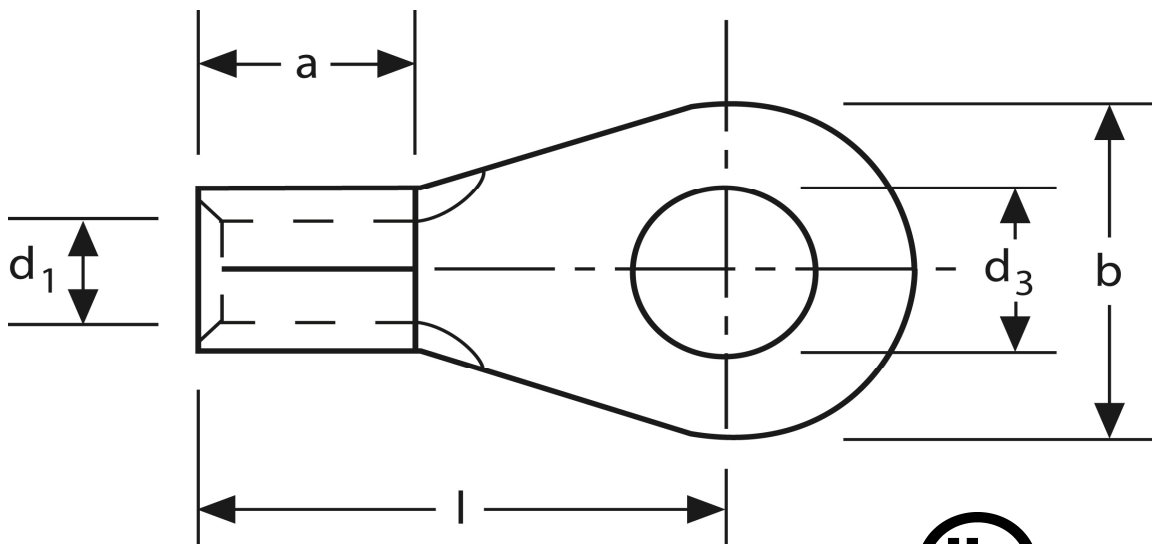

part no.	material	surface		
K 308080	E-CU	tin-plated	16,5 / 1000	100
	d₃	d₁	b	
in mm:	8,4	11,0	18	
	l	a	s	
in mm:	34	16	1,8	

date: 08.07.2014