

Lötkaabelschuh

Ringform

2,5 mm² M 4

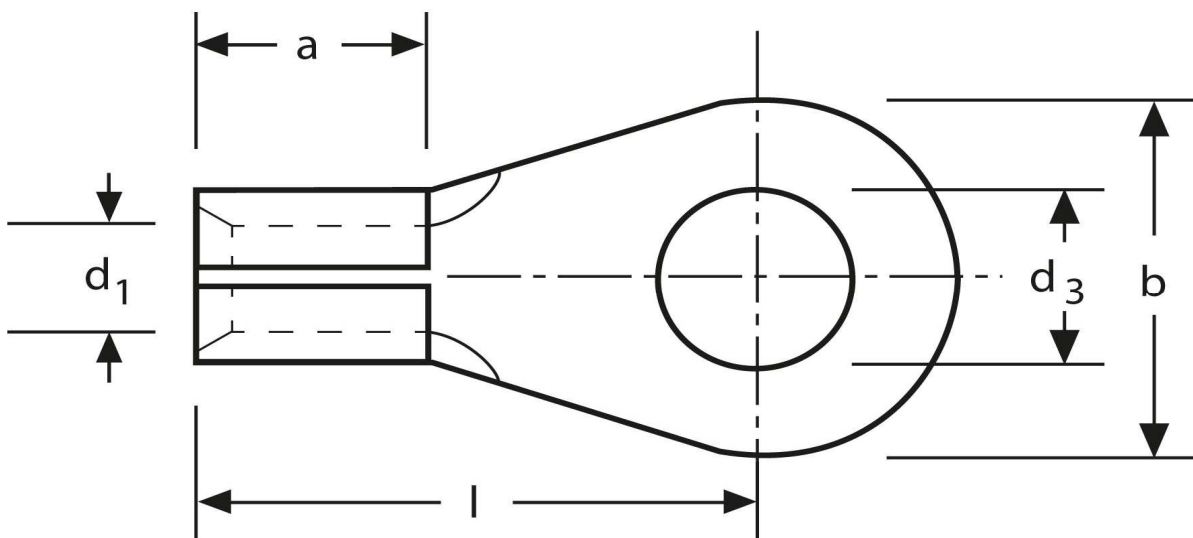

Artikel Nr.	Werkstoff	Oberfläche		
K 3102040	Messing	galv. Sn	0,84 / 1000	1.000
	d₃	d₁	b	
in mm:	4,3	2,3	8	
	l	a	Nenngröße	
in mm:	14,5	6,0	4 - 2,3	

Stand: 14.07.2014

Solder tags
 ring type
 2,5 mm² M 4

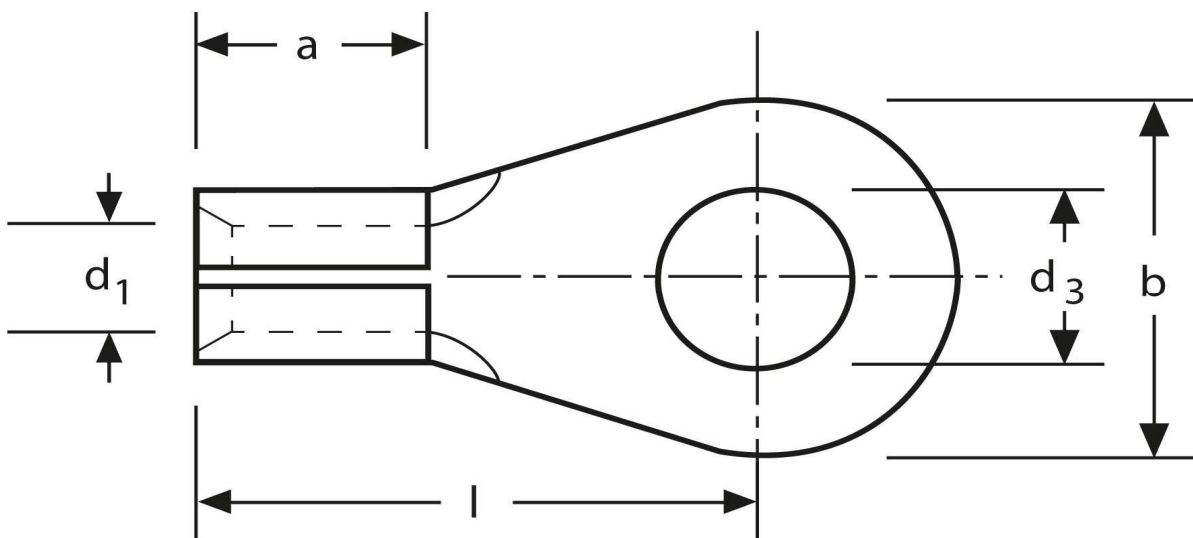

part no.	material	surface		
K 3102040	brass	tin-plated	0,84 / 1000	1.000
	d₃	d₁	b	
in mm:	4,3	2,3	8	
	l	a	nominal size	
in mm:	14,5	6,0	4 - 2,3	

date: 14.07.2014