

## Rohrkabelschuhe

handelsüblich

16 mm<sup>2</sup> M8

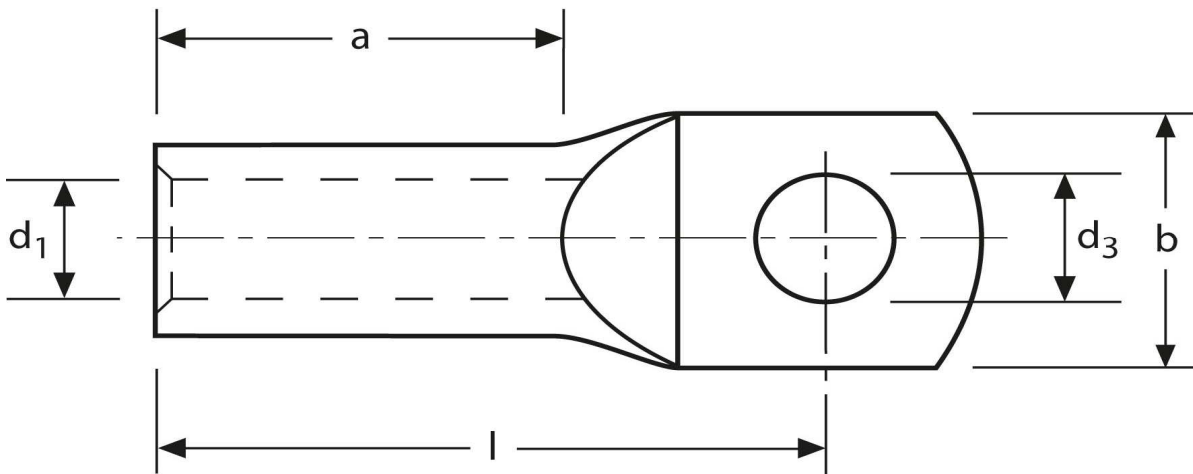

Art.Nr.	Werkstoff	Oberfläche		
K337080	E-CU	galv. Sn	9,7/ 1000	100
	<b>d<sub>3</sub></b>	<b>d<sub>1</sub></b>	<b>b</b>	
<b>in mm:</b>	8,5	5,5	15,0	
	<b>l</b>	<b>a</b>		
<b>in mm:</b>	27,6	13		

Stand: 09.10.2014

**Tubular cable-lugs**  
 commercial  
 16 mm<sup>2</sup> M8

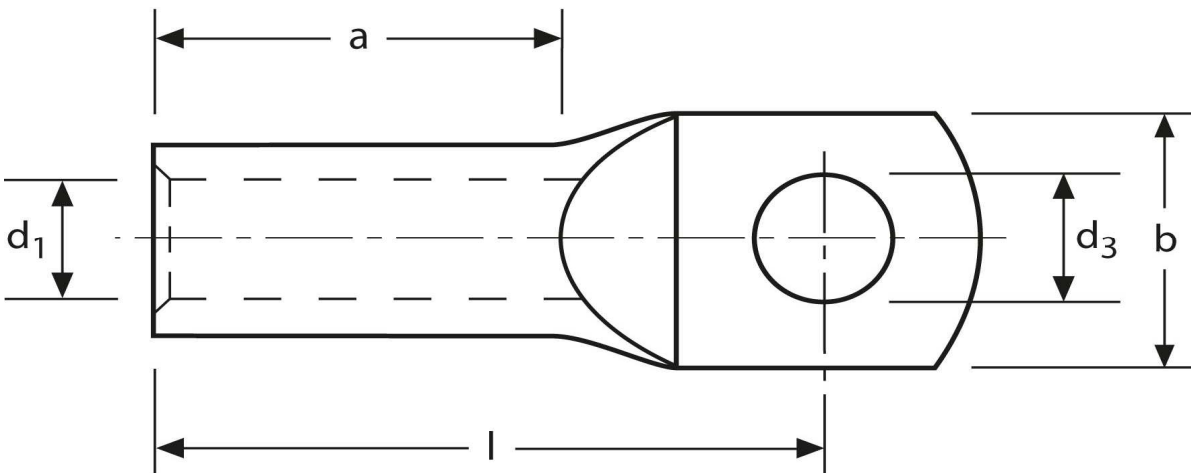

part no.	material	surface		
K337080	E-CU	tin-plated	9,7/ 1000	100
	<b>d<sub>3</sub></b>	<b>d<sub>1</sub></b>	<b>b</b>	
<b>in mm:</b>	8,5	5,5	15,0	
	<b>l</b>	<b>a</b>		
<b>in mm:</b>	27,6	13		

date: 09.10.2014