

Rohrkabelschuhe

handelsüblich

35 mm² M14

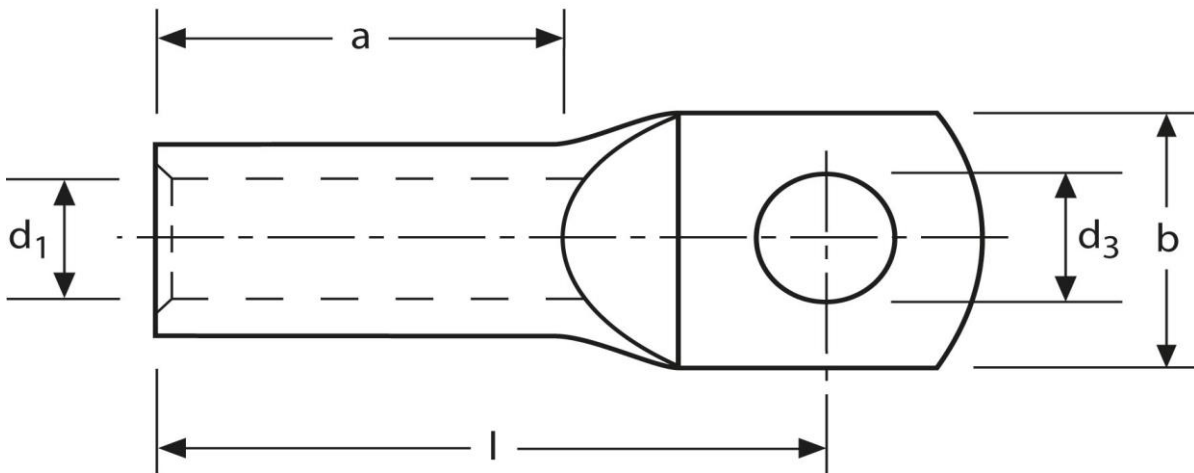

Art.Nr.	Werkstoff	Oberfläche		
K339140	E-CU	galv. Sn	22,2/ 1000	50
	d₃	d₁	b	
in mm:	15,0	8,5	21,0	
	l	a		
in mm:	38,5	17		

Stand: 13.11.2014

Tubular cable-lugs
commercial
35 mm² M14

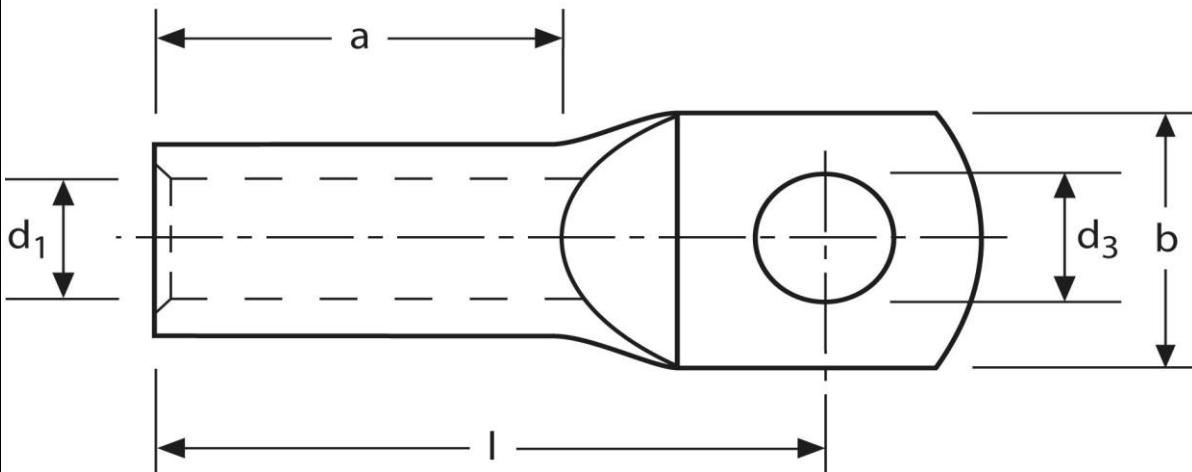

part no.	material	surface		
K339140	E-CU	tin-plated	22,2/ 1000	50
	d₃	d₁	b	
in mm:	15,0	8,5	21,0	
	l	a		
in mm:	38,5	17		

date: 13.11.2014