

**Kleinkabelschuh**  
Ringform, mit Sichtloch  
1,5 mm<sup>2</sup> M4

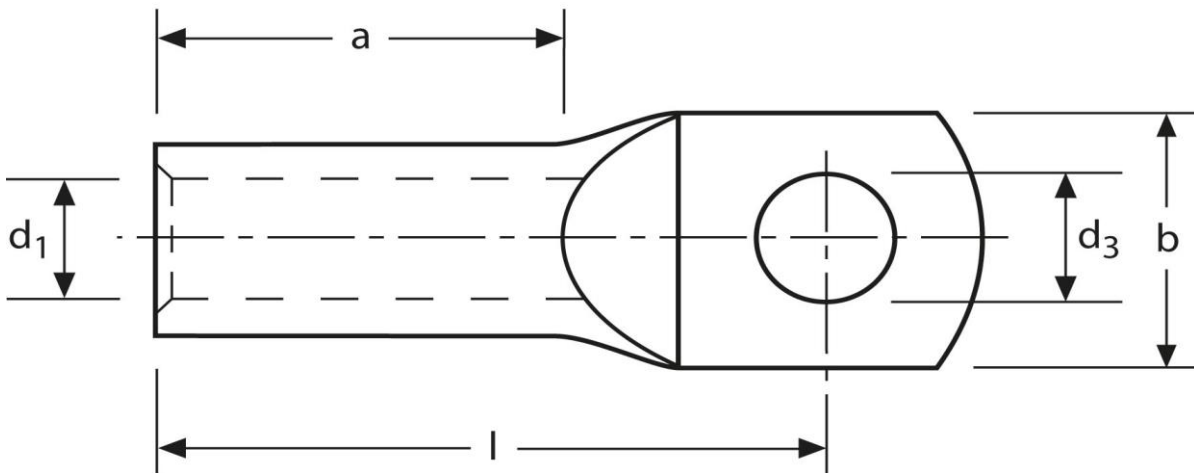

Art.Nr.	Werkstoff	Oberfläche		
K376040	E-CU	galv. Sn	1,29 / 1000	100
	d <sub>3</sub>	d <sub>1</sub>	b	
in mm:	4,3	1,8	6,5	
	l	a		
in mm:	13	6		

Stand: 17.10.2016

**Mini cable-lugs**  
 ring-type, with inspection hole  
 1,5 mm<sup>2</sup> M4

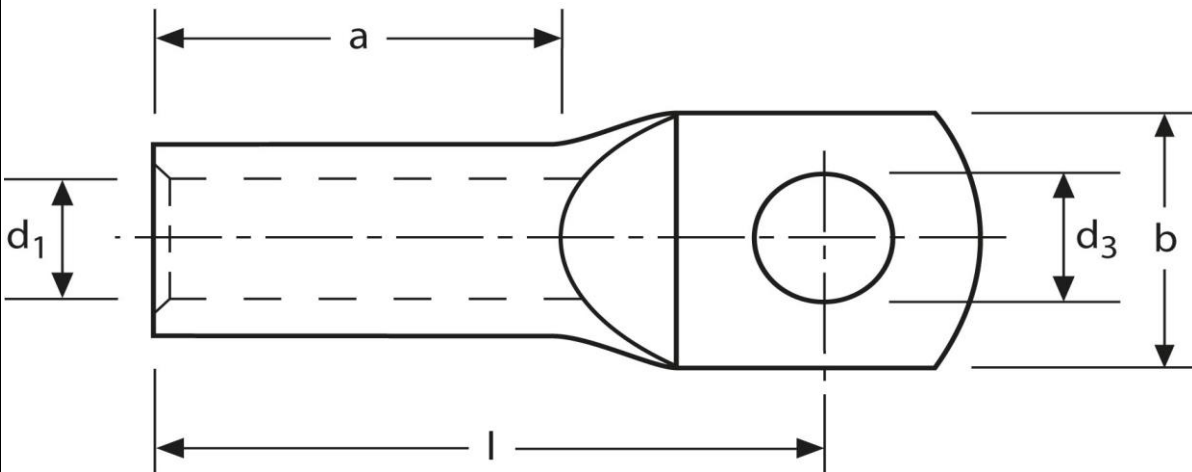

part no.	material	surface		
K376040	E-CU	tin-plated	1,29 / 1000	100
	<b>d<sub>3</sub></b>	<b>d<sub>1</sub></b>	<b>b</b>	
<b>in mm:</b>	4,3	1,8	6,5	
	<b>l</b>	<b>a</b>		
<b>in mm:</b>	13	6		

date: 17.10.2016