

Kabelbinder Pan-Steel

AISI 316, beschichtet

201 - 7,9 mm

blau

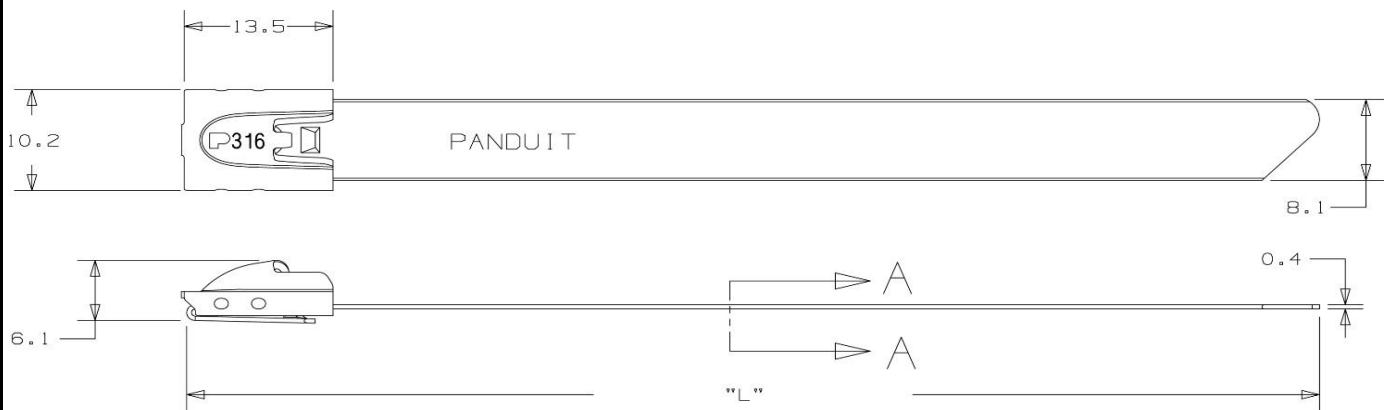

Art.Nr.	Werkstoff	Beschichtung
PA-MLTFC2H-LP316BU	Edelstahl AISI 316	Polyester, blau
	L	Kabelbaum max.
in mm:	201	51
	Temperaturbereich	Zugfestigkeit
	-40°C bis + 150°C	min. 1112 N

Stand: 02.01.2017